

66" NOELANI OVAL ACRYLIC FREESTANDING TUB

Cat. No.
ATOVN66IG-XX



L: 66-³/₈"
W: 32"
H: 21-³/₈"

Water depth: 16-¹/₄" to top of tub
Water depth: 12-⁷/₈" to overflow
Overflow slot length: 2-³/₄"
Center drain to back of rim:
Bottom of drain to floor: 3-³/₄"
Bathing well to floor: 4-³/₄"
Sitting area: 14-¹/₂"

The following is recommended for ATOVN66IG tubs:

- Faucets: part #4602, 4604, 7082, or 7088
- Rigid, Freestanding Supplies: part #4502
- Freestanding filler: part #7902, 7922, or 7932
(Supplies included with filler)

Gallon Capacity: 69
Shipping Weight: 145 lbs.
Empty Weight: 79 lbs.
Filled Weight: 652 lbs.

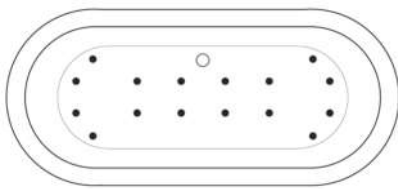

(Air jet configuration if system is added, more info on page 2.)

Features:

- ▶ Interior and exterior walls acrylic sheets
- ▶ 1" thick at rim
- ▶ Angle slope of tub: 50°
- ▶ No faucet holes
- ▶ Built-in overflow slot
- ▶ Tub is thoroughly inspected before shipment
- ▶ Drain and overflow covers included (available in 8 finishes)
- ▶ Option to add foam insulation between tub walls available
- ▶ **New:** Air jet system now available, more info on page 2
- ▶ **Tub exterior colors: White, Matte White, or Matte Black**

Finish:

BN	Brushed Nickel	WT	Matte White
CP	Polished Chrome	PN	Polished Nickel
MB	Matte Black	WH	White
ORB	Oil Rubbed Bronze	BGD	Brushed Gold

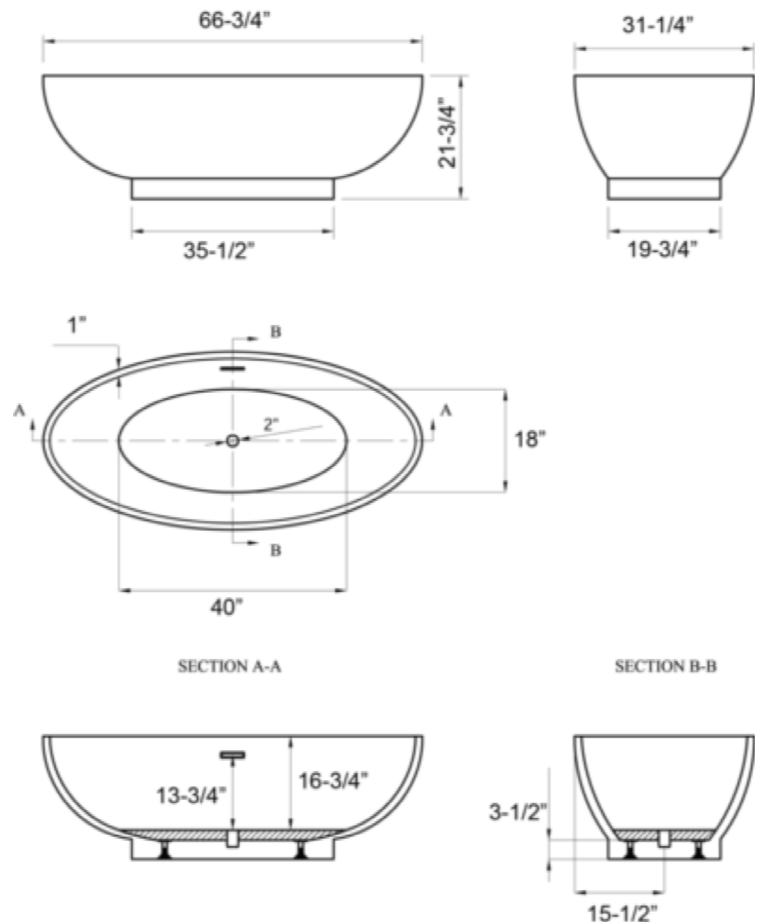

Dimensions of fixture are nominal and specifications subject to change without notice.

BATHTUB AIR JET KIT

Cat. No.
AIR KIT 1, AIR KIT 2

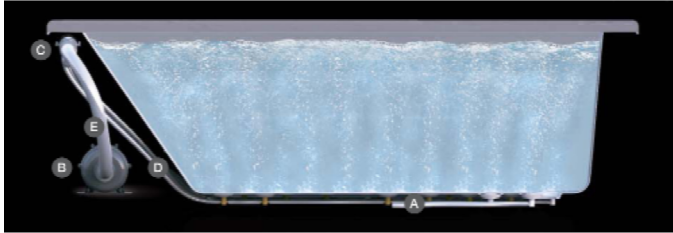

- A** AIR JET - Bottom air jets for maximum bubble action.
- B** BLOWER - The heart of the massage system.
- C** MANIFOLD - Double back flow security prevention device.
- D** FLEXIBLE PVC HOISING - IAPMO certified.
- E** MAIN AIR INTAKE HOSE - High temperature and pressure resistant.

Air Kit is installed in tub before shipment

Features:

- ▶ 750 Watt blower motor operates system
- ▶ 300 Watt air heater warms air
- ▶ System powered by 120V
- ▶ 16 brass air jets placed in bottom of tub
- ▶ Each air jet has 24 holes
- ▶ Air jet caps available in white (AIR KIT 1) or black (AIR KIT 2)
- ▶ Includes 1 1/4" x 3' main air hose plus 1 1/4" x 9' extension hose
- ▶ Automatic system purge after each use
- ▶ Automatic safety timer turns off system after 20 minutes
- ▶ Includes water tight remote control
- ▶ Compatible with most acrylic, copper and resin tubs with no feet
- ▶ Not available with cast iron tubs or tubs with feet

INSIDE TUB VIEW - WILL VARY BY TUB DESIGN



Air Jet



Remote

Oval bathtub
Sample jet configuration

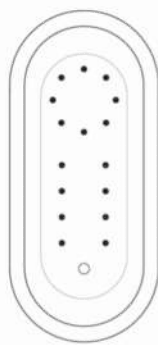

with end drain

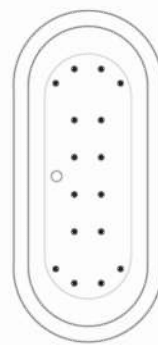

with center drain

Rectangular bathtub
Sample jet configuration

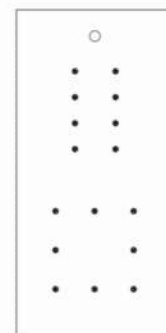

with end drain

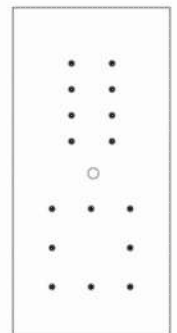

with center drain

Round bathtub
Sample jet configuration

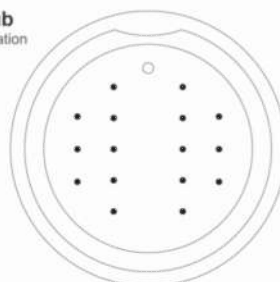

These diagrams are general representations.
Jet placement may vary dependent on tub shape

Features:

(16) Maxi Air Jets



Elbows for air jets



Tees for air jets